

Specification Datasheet

Copy right 20170508 / Ver B -

Ergon COB 1512HO

- 22.5W maximum power capability
- High brightness LED
- Dimension : 15.85 x 15.85 x 1.70 mm
- Precondition : JEDEC Level 2a
- Lead-free reflow soldering application
- RoHS compliant

Table of Contents

1. Product description	3
2. Absolute maximum ratings	3
3. Electro-optical characteristics($T_j=85\text{ }^\circ\text{C}$)	4
4. Electro-optical chart($T_j=85\text{ }^\circ\text{C}$)	4
5. Ranks	5
6. Chromaticity diagram & coordinates	6
7. Characteristic Graphs($T_j=85\text{ }^\circ\text{C}$)	7-9
8. Outline Dimensions	10
9. Circuit Design	10
10. Packing	11-12
11. Label Format	13
12. Reliability test items and conditions	14
13. Cautions	15-16

1. Product description

(1) Description

- The Ergon series LED is designed for the high power operation to get the high flux output applications.
- It is ideal for the light source for general illumination applications, custom designed solutions.

(2) Features

- Maximum drive current up to 600mA
- Low thermal resistance as low as 2.5°C/W
- Viewing angle of 115 degrees
- Precondition JEDEC Level 2a
- RoHS compliant

(3) Applications

- Indoor lighting, Outdoor lighting, Industrial lighting

2. Absolute maximum ratings

Parameters	Symbol	Value	Unit
Power dissipated	Pd	22.5	W
Rated forward current	If	600	mA
Maximum junction temperature capability(1)	Tj	125	°C
Operating temperature	Top	- 40 ~ +85	°C
Storage temperature	Tst	- 40 ~ +100	°C

- (1) Proper current derating must be observed to maintain junction temperature below the maximum.

3. Electro-optical characteristics (Tj=85°C)

Parameters	Symbol	If(mA)	Typ.	Unit
Forward voltage	Vf	330	34.0	V
Viewing angle FWHM	2θ1/2	330	115	degrees
Thermal resistance junction to solder pad	Rthj-a		2.5	°C/W

- Lumens maintains a tolerance of ±3% on forward voltage measurements.

4. Electro-optical chart (Tj=85°C)

CCT(K)	CRI	If(mA)	Vf(V)	Pd(W)	Typ. Φv(lm)	lm/W
2700	80	330	34.0	11.2	1421	126.6
3000		330	34.0	11.2	1460	130.1
3500		330	34.0	11.2	1492	133.0
4000		330	34.0	11.2	1544	137.6
5000		330	34.0	11.2	1566	139.6
5700		330	34.0	11.2	1539	137.2
2700	90	330	34.0	11.2	1182	105.3
3000		330	34.0	11.2	1215	108.3
3500		330	34.0	11.2	1241	110.6
4000		330	34.0	11.2	1285	114.5
5000		330	34.0	11.2	1303	116.1

- Lumens maintains a tolerance of ±7% on flux measurements.
- Lumens maintains a tolerance of ±3% on forward voltage measurements.
- Lumens maintains a tolerance of ±2 on CRI measurements.

5. Ranks

Item	Symbol	CCT(K)	Min.	Typ.	Unit	CRI	If(mA)			
Luminous Flux	Φ_v	2700	1279	1421	lm	80	330			
		3000	1314	1460	lm					
		3500	1343	1492	lm					
		4000	1390	1544	lm					
		5000	1410	1566	lm					
		5700	1386	1539	lm					
		2700	1064	1182	lm	90				
		3000	1093	1215	lm					
		3500	1117	1241	lm					
		4000	1156	1285	lm					
		5000	1173	1303	lm					
		Forward Voltage	Vf	-	31.0	34.0		V	-	

- Lumens maintains a tolerance of $\pm 7\%$ on flux measurements.
- Lumens maintains a tolerance of $\pm 3\%$ on forward voltage measurements.
- Lumens maintains a tolerance of ± 2 on CRI measurements.

6. Chromaticity diagram & coordinates

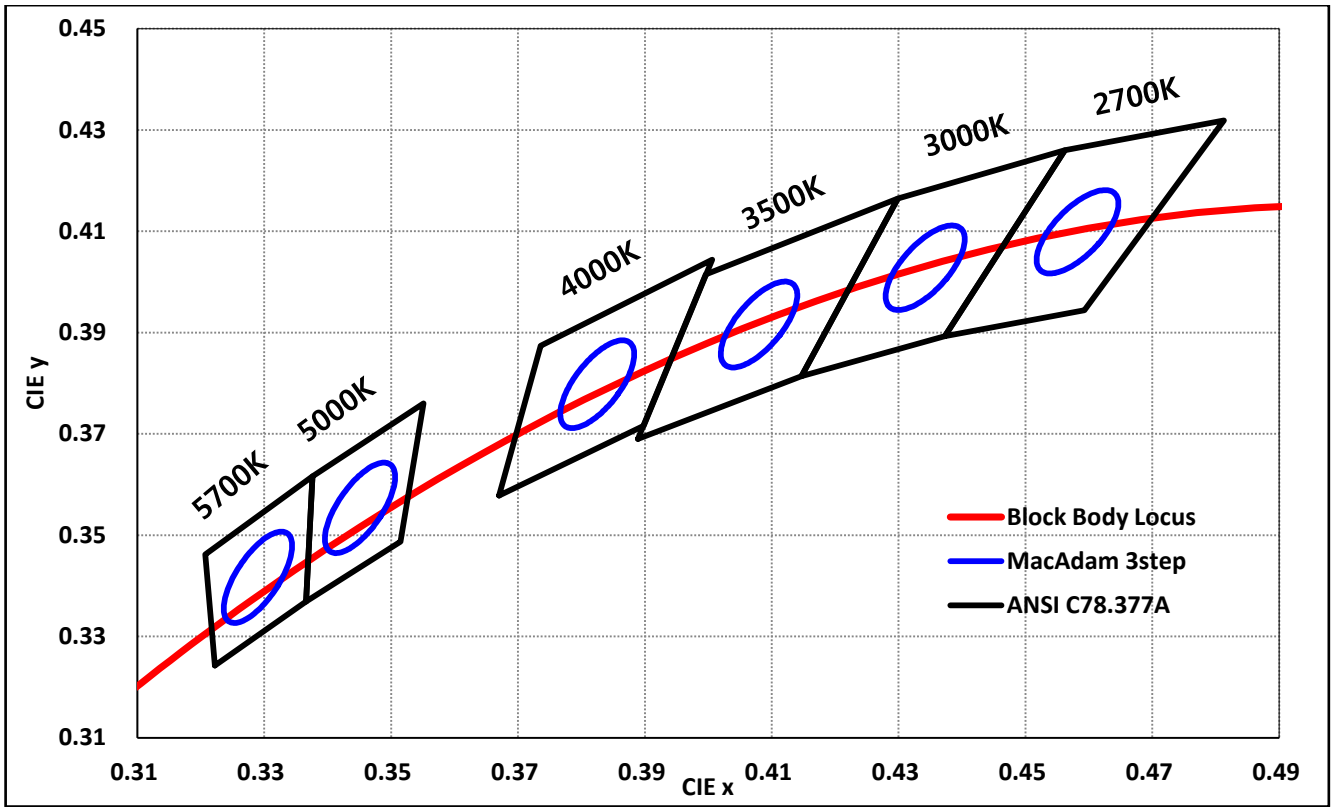

- Lumens maintains a tolerance of ± 0.005 on chromaticity (CCx, CCy)

CCT(K)	x	y	CCT(K)	x	y	CCT(K)	x	y
5700K	0.3222	0.3243	4000K	0.3670	0.3578	3000K	0.4147	0.3814
	0.3207	0.346		0.3736	0.3874		0.4299	0.4165
	0.3376	0.3616		0.4006	0.4044		0.4562	0.4260
	0.3366	0.3369		0.3898	0.3716		0.4373	0.3893
5000K	0.3366	0.3369	3500K	0.3889	0.3690	2700K	0.4373	0.3893
	0.3376	0.3616		0.3996	0.4015		0.4562	0.4260
	0.3551	0.3760		0.4299	0.4165		0.4813	0.4319
	0.3515	0.3487		0.4147	0.3814		0.4593	0.3944

* 3-step MacAdam Ellipse Color Definition

CCT(K)	Center		Ellipse Parameter		
	x	y	Axis a	Axis b	Angle(°)
5700K	0.3287	0.3417	0.00745	0.00320	59.1
5000K	0.3447	0.3553	0.00822	0.00354	59.6
4000K	0.3818	0.3797	0.00939	0.00402	53.7
3500K	0.4073	0.3917	0.00927	0.00414	54.0
3000K	0.4338	0.4030	0.00834	0.00408	53.2
2700K	0.4578	0.4101	0.00810	0.00420	53.7

7. Characteristic Graphs(Tj=85°C)

(1) Typical Forward Current vs. Forward Voltage

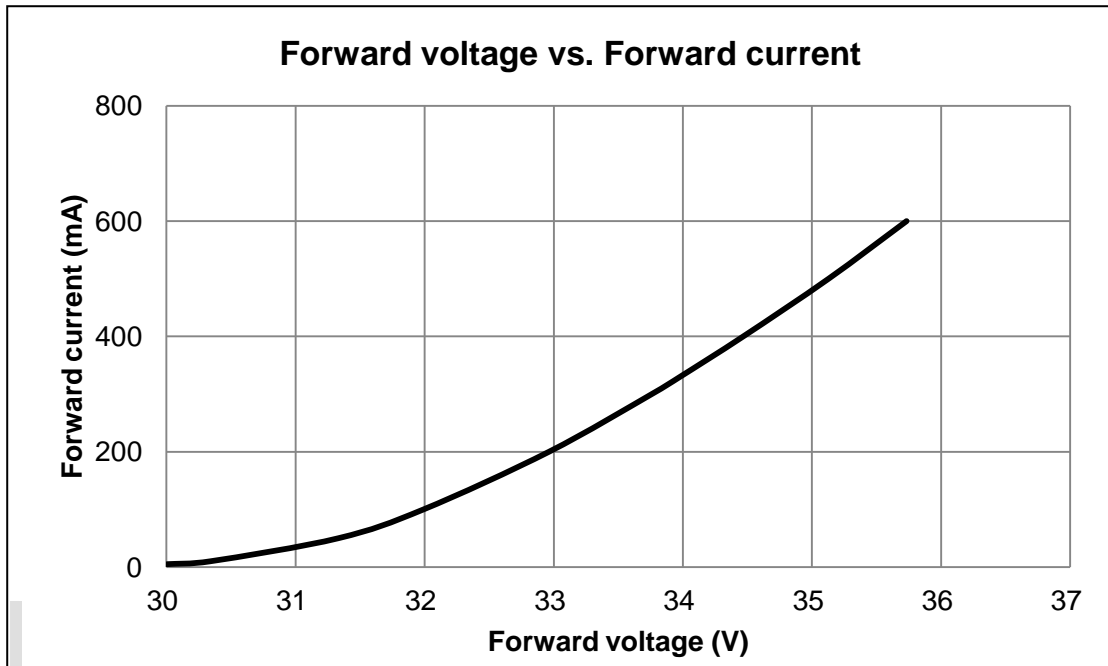

(2) Typical Relative Luminous Flux vs. Forward Current

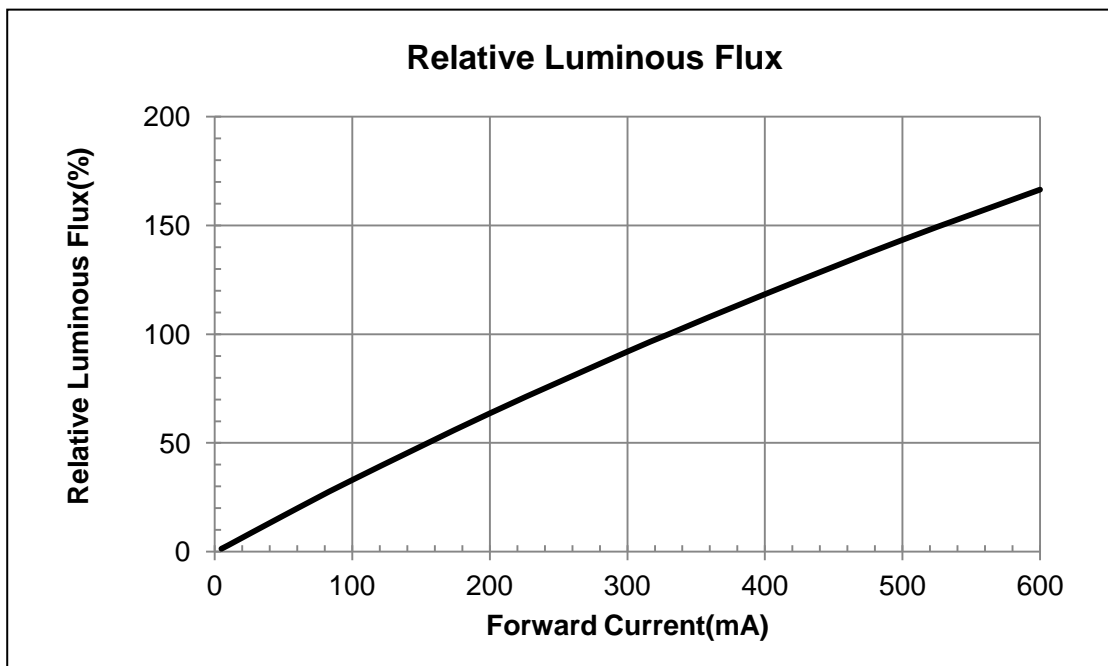

(3) Typical Allowable Forward Current with Ambient Temperature

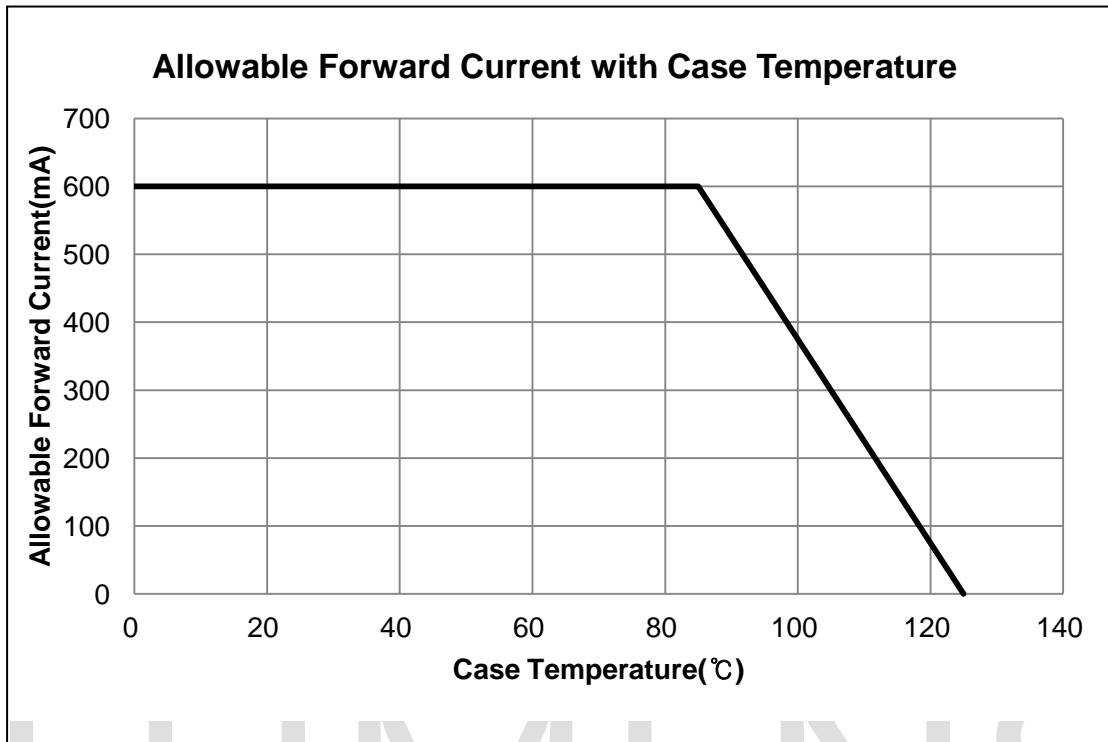

(4) Typical Spatial Radiation Characteristic

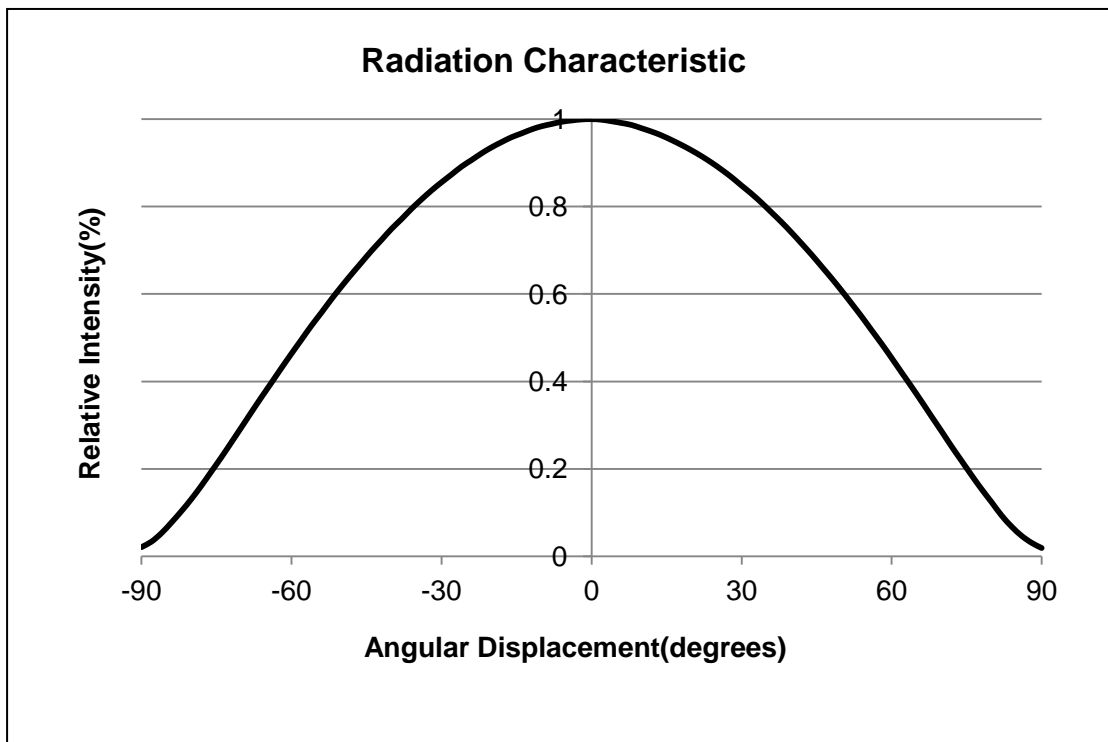

(5) Spectrum

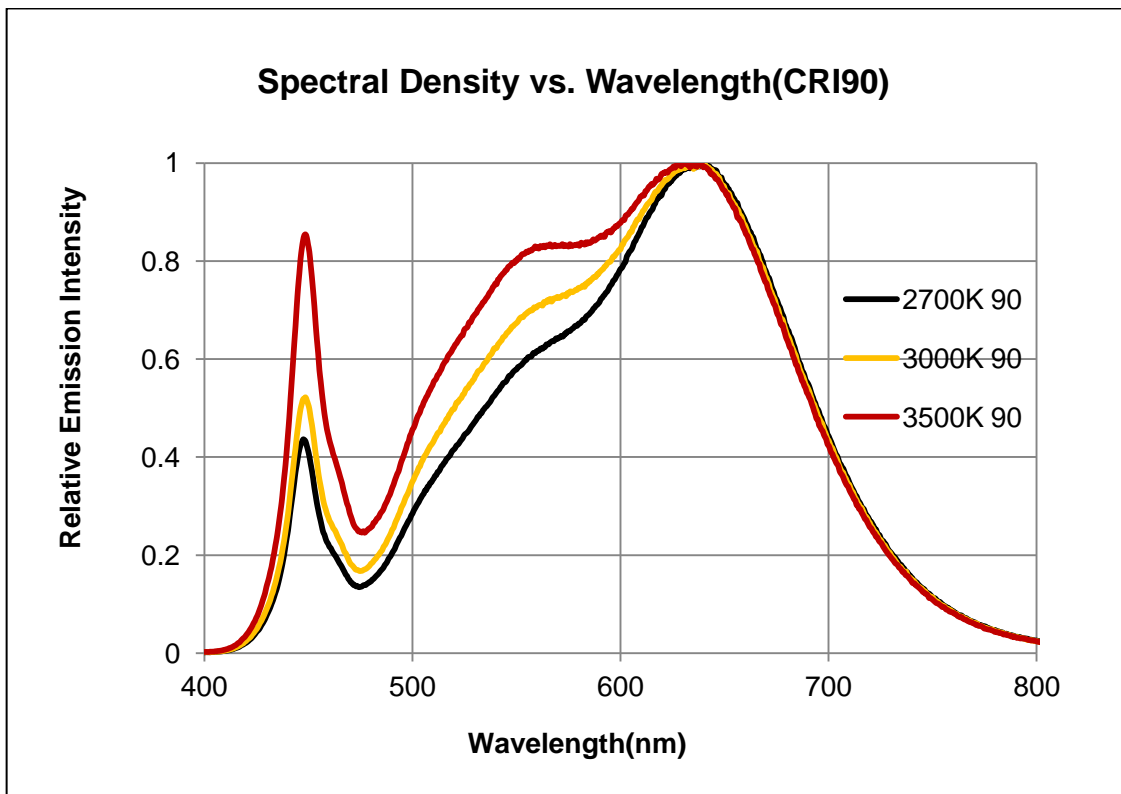
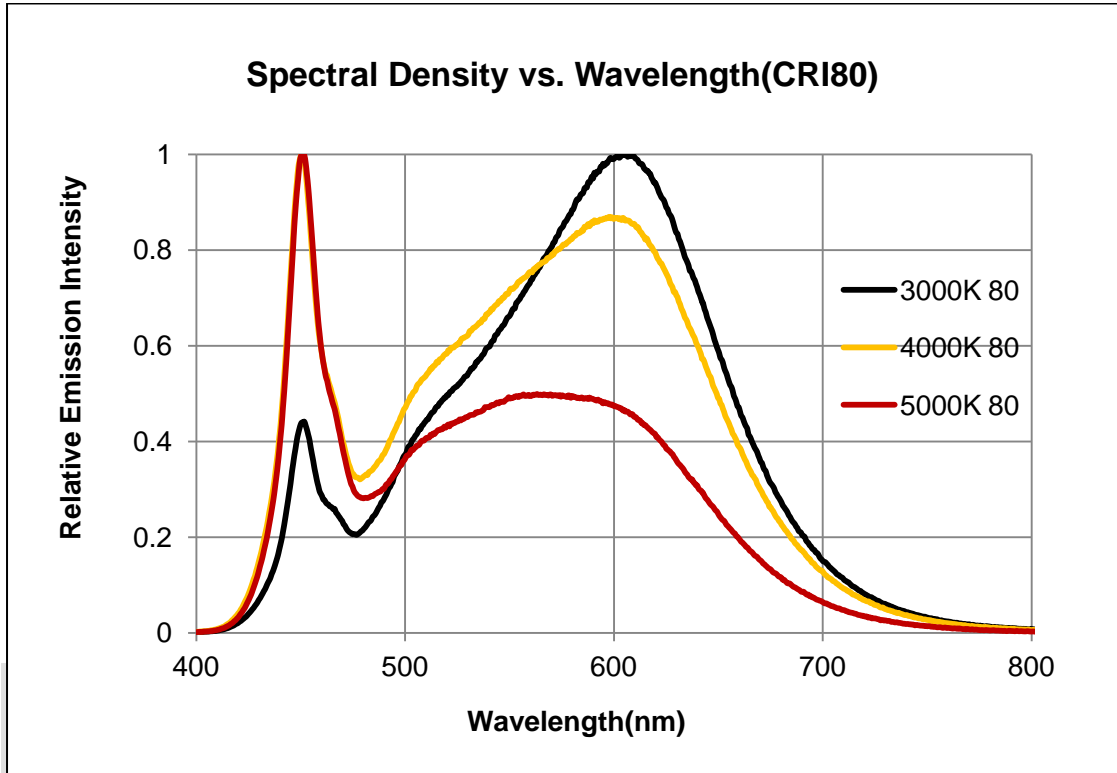

8. Outline Dimensions

- Package outline (Width x Length x Height) of 15.85 x 15.85 x 1.70mm
- Undefined tolerance is ± 0.2 mm

(Unit : mm)

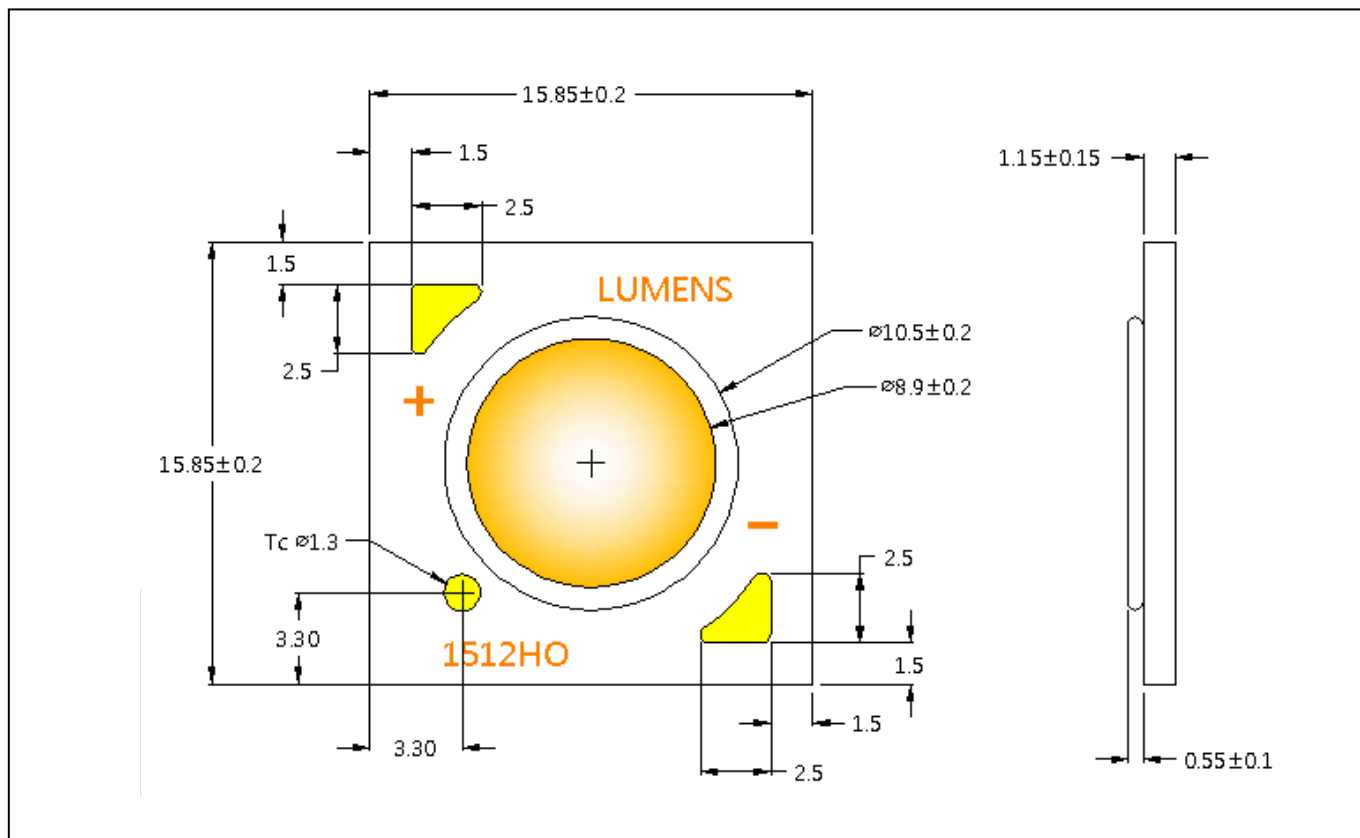

9. Circuit Design

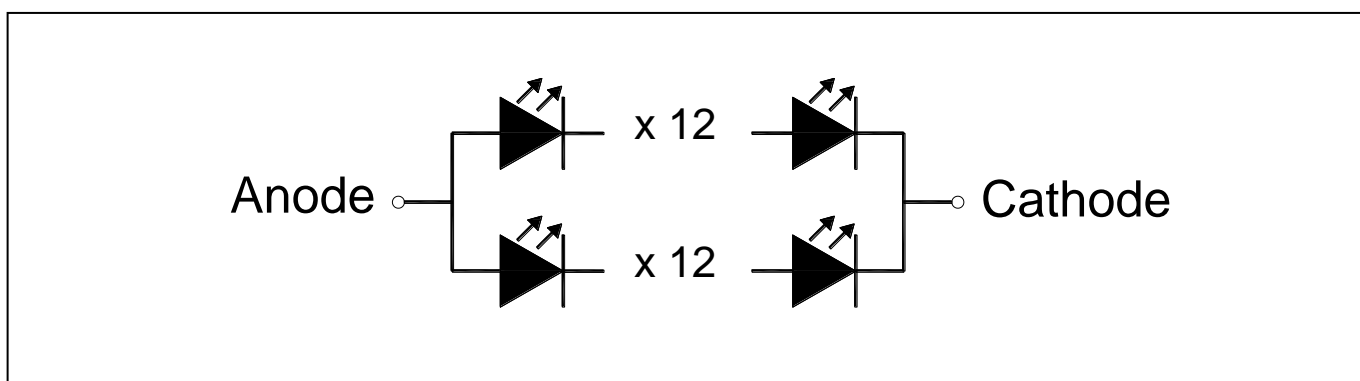

10. Packing

- 36pcs modules per tray
- 10 trays in one Carton
- Tray Size: LxW=200 x 190(mm) 6X 6=36pcs.
- Carton Size: 215mm x 205mm x 150mm
- Undefined tolerance is ± 2 mm

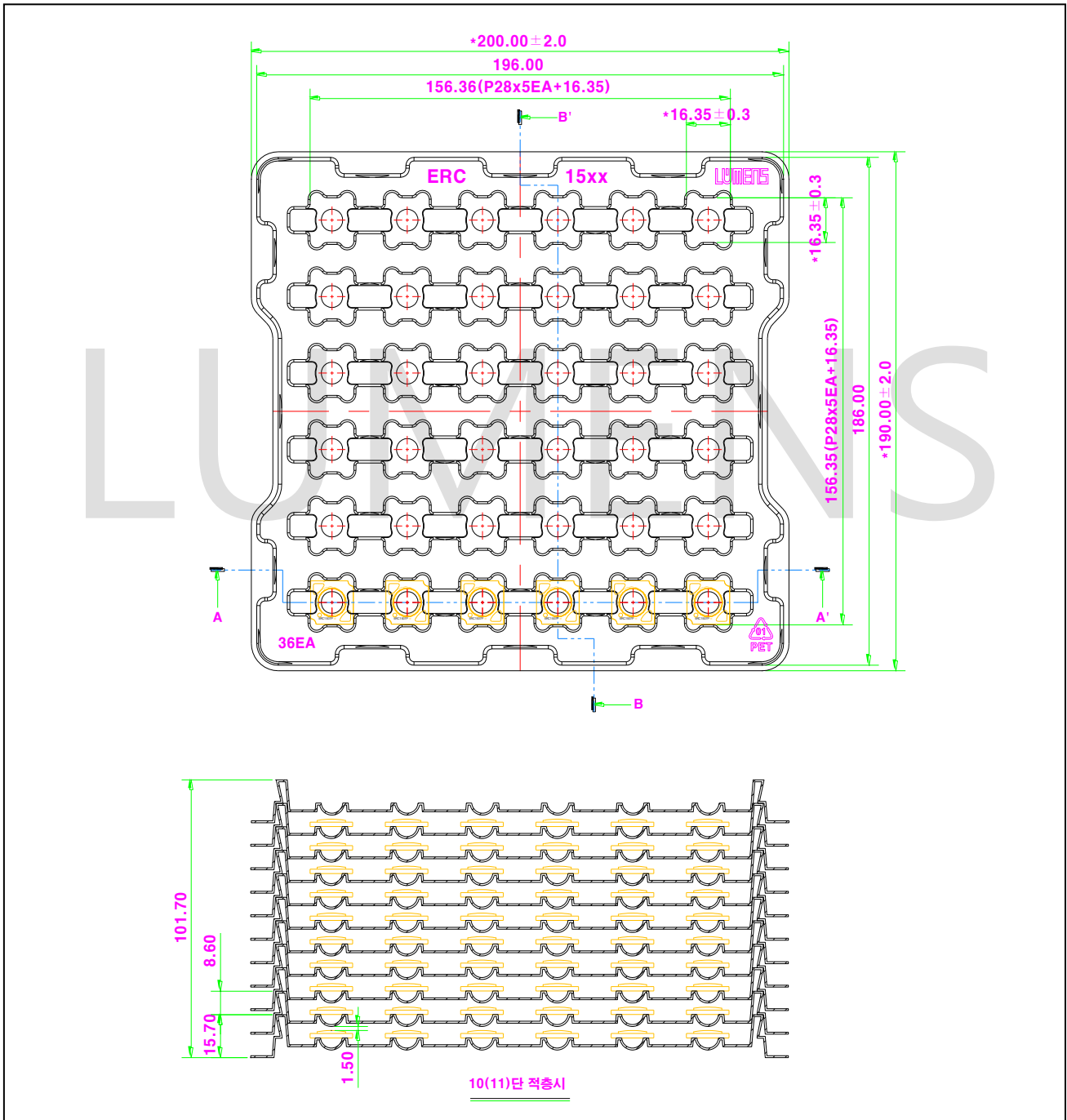

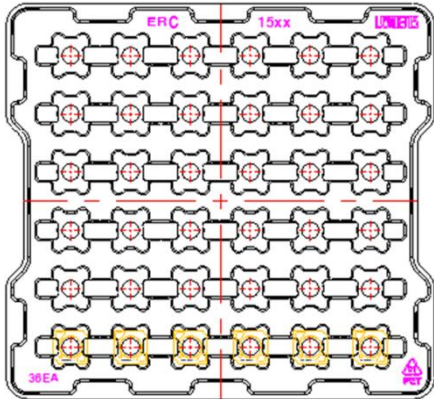

*1Tray unit = 36pcs (6x6 Array)
 *Tray Size = 200mm(L) * 190mm(W)

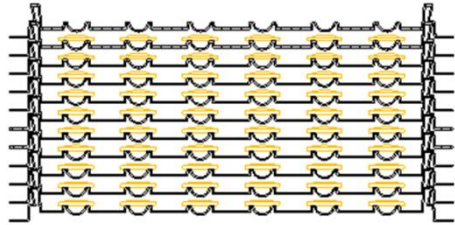

*1Set = 11Tray (10Tray+1Cover)
 *Total size = 200mm(L)*190mm(W)*103mm(H)
 *Quantity = 36*10=360pcs

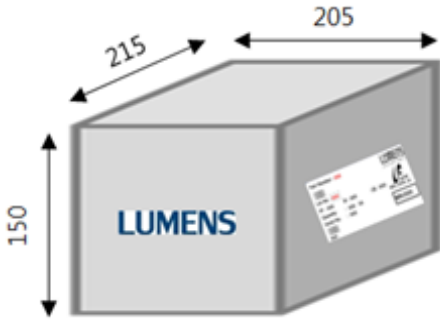

*Box size = 215mm(L)*205mm(W)*150mm(H)
 *Attached label : Production Info.
 *Quantity = 36*10=360pcs

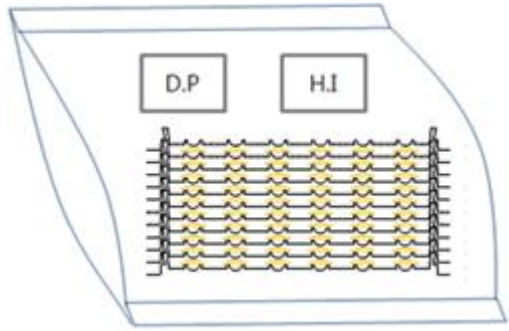

*Poly-bag size = 275*435*160mm
 *1Set + Dry-Pack + Humidity Indicator
 *Quantity = 360pcs

11. Label Format

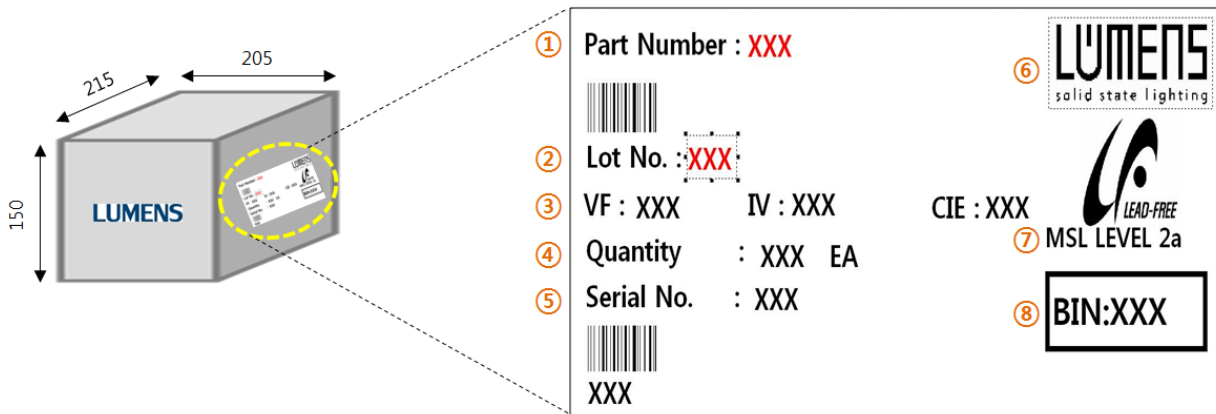

No.	ITEM	REMARK	DESCRIPTION
①	PART NUMBER	ECxxxxxxxxxx - xxxx	EC : Ergon COB (Series, Size, Type, Color, CRI, CCT, VF)
②	LOT NUMBER	xx-xxx - YYMMDDW -Lxxx	Production Input (Input date, Product model size, Lot no.) Y(Year), M(Month), D(Day)
③	VF / IV / CIE	VF : Forward voltage IV : Luminous flux CIE : CCT+CRI	VF : xx - xx IV : xx - xx CIE : 827(2700K+80Ra)
④	QUANTITY	xxx EA	Total Q'ty
⑤	SERIAL NUMBER	xxx-YYMMDD	Y(Year), M(Month), D(Day)
⑥	COMPANY LOGO	LOGO	-
⑦	MSL LEVEL	Moisture Sensitivity Level	ex) MSL1 ~ 6
⑧	BIN No.	00xx ~ 90xx	TEST Bin No.

12. Reliability test items and conditions

Item	Reference	Test Conditions	Duration Cycle
Thermal Shock	EIAJ ED-4701	Ta = - 40°C (30min) ~ 100°C (30min)	100 Cycle
Operating Endurance Test	Internal Reference	Ta =25°C, IF = 330mA	1000 Hours
High Temperature High Humidity Life Test	Internal Reference	85°C, 85% RH	500 Hours
Low Temperature Storage Test	Internal Reference	Ta = -40°C	1000 Hours
High Temperature Storage Test	Internal Reference	Ta = 100°C	1000 Hours

(1) Criteria for judging the damage

Item	Symbol	Condition	Criteria for Judgment	
			MIN	MAX
Forward Voltage	Vf	If = 330mA	-	USL (1) × 1.1
Luminous Intensity	Φv	If = 330mA	LSL (2) × 0.7	-

- USL : Upper Standard Level
- LSL : Lower Standard Level

13. Cautions

(1) Moisture-Proof Package

- 1.1 When moisture is absorbed into the LED package it may vaporize and expand products during soldering. There is a possibility that this may cause exfoliation of the contacts and damage to the optical characteristics of the LEDs. For this reason, the moisture-proof package is used to keep moisture to a minimum in the package.
- 1.2 A package of a moisture-absorbent material (silica gel) is inserted into the shielding bag. The silica gel changes its color from blue to pink as it absorbs moisture.

(2) Current limiting

A resistor should be used to limit current spikes that can be caused by voltage fluctuations. Otherwise damage could occur.

(3) Storage Conditions

- 3.1 Before opening the package: The LEDs should be kept at 30°C or less and 90%RH or less. The LEDs should be used within a year. When storing the LEDs, moisture-proof packaging with moisture-absorbent material (silica gel) is recommended.
- 3.2 After opening the package: The LEDs should be kept at 30°C or less and 70%RH or less. The LEDs should be soldered within 168 hours (7 days) after opening the package. If unused LEDs remain, they should be stored in moisture-proof packages, such as sealed containers with packages of moisture-absorbent material (silica gel). It is also recommended to return the LEDs to the original moisture-proof bag and to reseal the moisture-proof bag again.
- 3.3 If the moisture-absorbent material (silica gel) has faded away or the LEDs have exceeded the recommended storage time, baking treatment should be performed using the following conditions.
Baking treatment: more than 24 hours at 65±5°C
- 3.4 Lumens LED electrode sections are comprised of a silver-plated copper alloy. The silver surface may be affected by environments which contain corrosive gases and so on. Please avoid condition which may cause difficulty environments during soldering operations. It is recommended that the user uses the LEDs as soon as possible.
- 3.5 Please avoid rapid transitions in ambient temperature, especially in high humidity environments where condensation can occur.

(4) Handling of Silicone (Lens) LEDs

- 4.1 Avoid silicone resin parts especially with sharp tools such as tweezers.
- 4.2 Avoid leaving fingerprints on silicone lens part.

(5) Usage

5.1 Do not exceed the values given in this specification.

LUMENS

NOTE :

All the information published is considered to be reliable. However, Lumens does not assume any liability arising out of the application or use of any product described herein.

Lumens reserves the right to make changes at any time without notice to any products in order to improve reliability, function or design.

Lumens products are not authorized for use as critical components in life support devices or systems without the express written approval from the managing director of Lumens.