

EDC F2 Series

- Ver0.5 -

EDC/47C/6W/XXX/2XXV/F201

- Compatible with most TRIAC dimmers
- High Power Factor (>0.95)
- Low THD (<30%)
- Zhaga Standard Mounting Holes
- 30mA Inrush current
- No photo-biological hazard (RG1)
- Uniform Full Dimming
- Percent Flicker (<5%)
- Low SVM (<0.1)
- Low Pst (<0.4)

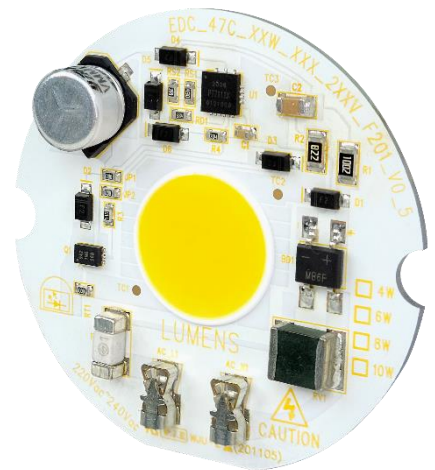

EggDrop®

1. Product Description

* Description

- The EDC(Egg Drop COB) series module is designed for the high power operation to get the high flux output applications.
- It incorporates the state of the art SMD LEDs with high reliability and semiconductor AC direct drive ICs.
- It is ideal for the indoor or down light applications.

* Features

- High performance, High brightness
- No emission of harmful short wavelength light(No UV radiation)
- High power conversion efficiency(>0.85)
- High power factor (>0.95)
- Low THD($\leq 30\%$)
- Low EMI
- RoHS compliant
- No photo-biological hazard –Group 1 (Low risk) (RG1)
- Starting current 27 [mA] @ 60ms
- Percent Flicker (<5%)
- SVM (<0.1)
- Pst (<0.4)

* Applications

- Down Light (Indoor Lighting)
- Spot Light

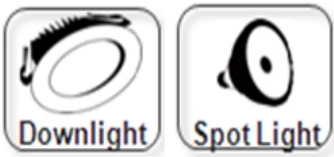

2. Absolute Maximum Ratings

Parameters	Symbol	Min Value	Max Value	Unit
Maximum power dissipation	Pd	-	6.6	W
Maximum operation voltage	Vop	-	250	V
Operation temperature	Top	-40	+85	°C
Storage temperature	Tst	-40	+100	°C

- Operation temperature is not related to the lifetime.

3. Product Name Method

(ex. Eggdrop)

Product Family	PCB Size/shape		Power	CRI+CCT		Input Voltage	Management Code				Version
EDC	57	C	XXW	X	XX	XXXV	F	2	0	1	V0_1
'EDC'=EggDrop	Ø33	'C'=Circular	10W	'7'=70 ↑	'27'=2700K	'120V'=120Vac					
'DLM'=DownLight	Ø38	'R'=Rectangular	15W	'8'=80 ↑	'30'=3000K	'220V'=220Vac					
	Ø47	'D'=Donut	ETC.	'9'=90 ↑	'35'=3500K	'230V'=230Vac					
	Ø57	ETC.			'40'=4000K	ETC.					
	Ø80				'50'=5000K						
'LNM'=Linear Bar	280X20				'57'=5700K						
	560X20										

1) Additional explanation

Product Section		Product Description PCB Size>Shape>Watt>CRI+CCT>InputVoltage>Management Code
EggDrop	EDC	EDC_57C_XXW_XXX_XXXV_F201_V0_1
DownLight	DLM	DLM_80D_XXW_XXX_XXXV_A101_V0_1
Linear Bar	LNM	LNM_280X20_XXW_XXX_XXXV_C101_V0_1

4. Electro-optical Characteristics (Ta=25°C & 55°C.)

Parameters	Symbol	Ta = 25°C			Ta = 55°C			Unit	Condition
		Min.	Typ.	Max.	Min.	Typ.	Max.		
Luminous Flux	Φ_v	497	552	-	474	527	-	lm	2700K,CRI80
		540	600	-	516	573	-		3000K,CRI80
		551	612	-	526	584	-		3500K,CRI80
		562	624	-	536	596	-		4000K,CRI80
		575	639	-	549	610	-		5000K,CRI80
		572	636	-	547	607	-		5700K,CRI80
		427	475	-	408	453	-		2700K,CRI90
		464	516	-	444	493	-		3000K,CRI90
		474	526	-	452	503	-		3500K,CRI90
		483	537	-	461	512	-		4000K,CRI90
		495	550	-	472	525	-		5000K,CRI90
		492	547	-	470	522	-		5700K,CRI90
Efficiency	lm/W	83	92	-	79	88	-	lm / W	2700K,CRI80
		90	100	-	86	96	-		3000K,CRI80
		92	102	-	88	97	-		3500K,CRI80
		94	104	-	89	99	-		4000K,CRI80
		96	107	-	92	102	-		5000K,CRI80
		95	106	-	91	101	-		5700K,CRI80
		71	79	-	68	76	-		2700K,CRI90
		77	86	-	74	82	-		3000K,CRI90
		79	88	-	75	84	-		3500K,CRI90
		80	89	-	77	85	-		4000K,CRI90
		82	92	-	79	87	-		5000K,CRI90
		82	91	-	78	87	-		5700K,CRI90

(1) At 220~230Vac, T_c = 25°C & 55°C(2) Φ_v is the total luminous flux output measured with an integrated sphere.- Measurement accuracy : CRI(±3), Φ_v (±3%), Vf(±3.0V)

Viewing Angle FWHM	2θ1/2	110	120	130	deg	Vop=220~230V
Operation Voltage	Vop	220 ~ 230V			Vac	
Power Dissipation	Pd	5.4	6.0	6.6	W	Vop=220~230V
Rated Current	Ira	26	28	-	mA	Pd=6W
Operation Frequency	Fop	50 / 60			Hz	Vop=220~230V
Power Factor	PF	Over 0.95			V	Vop=220~230V
Current THD	ATHD	Less than 30%				Vop=220~230V
Percent Flicker	%	Less than 5%				Vop=220~230V
SVM		Less than 0.1				Vop=220~230V
Pst		Less than 0.4				Vop=220~230V

5. CIE Chromaticity Diagram

※ Correlated Color Temperature is derived from the CIE 1931 Chromaticity diagram.

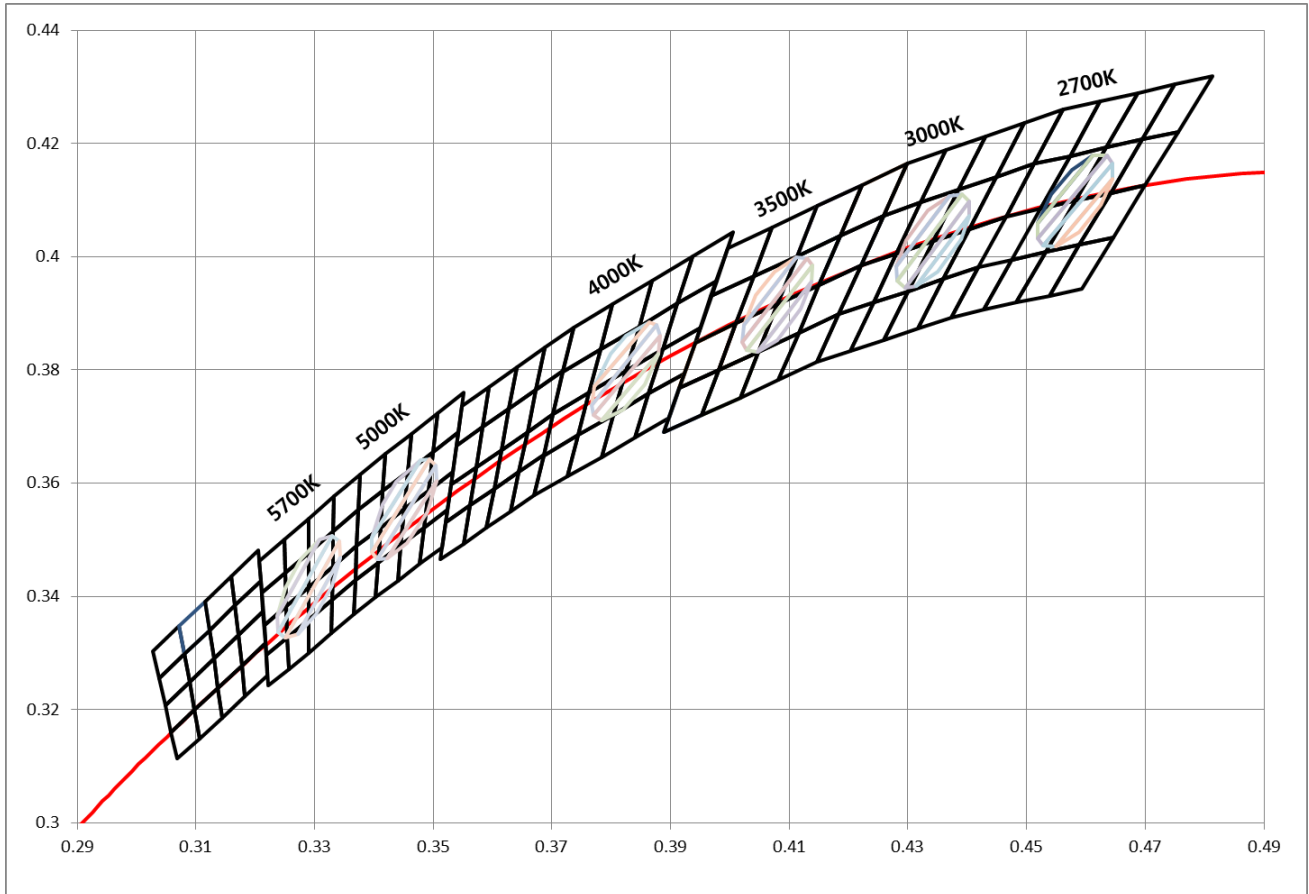

(1) Chromaticity coordinate groups are measured with an accuracy of ± 0.01

6. Chromaticity Coordinates

6-1. 2700K

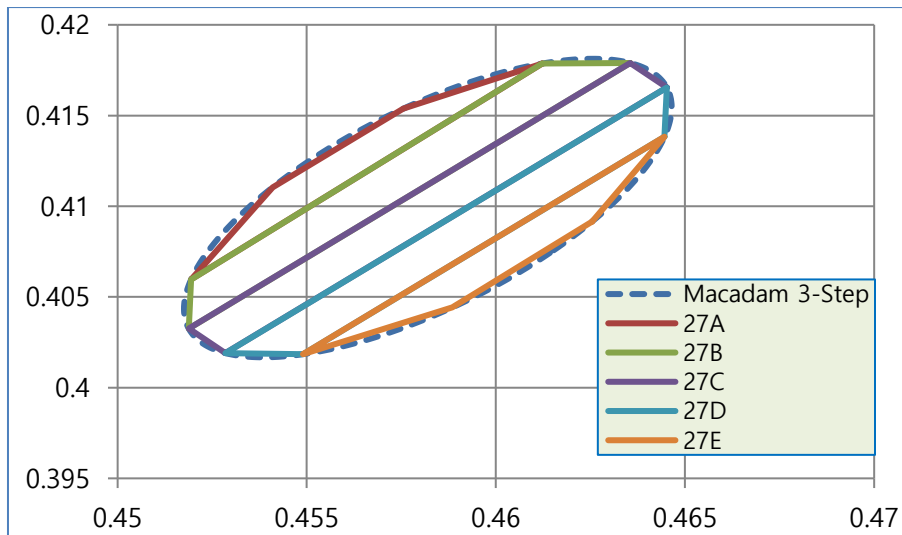

27A		27B		27C		27D		27E	
X	Y	X	Y	X	Y	X	Y	X	Y
0.4612	0.4179	0.4636	0.4179	0.4645	0.4165	0.4645	0.4138	0.4625	0.4092
0.4576	0.4154	0.4612	0.4179	0.4636	0.4179	0.4645	0.4165	0.4645	0.4138
0.4541	0.4110	0.4519	0.4060	0.4519	0.4033	0.4528	0.4019	0.4549	0.4018
0.4519	0.4060	0.4519	0.4033	0.4528	0.4019	0.4549	0.4018	0.4588	0.4044
0.4612	0.4179	0.4636	0.4179	0.4645	0.4165	0.4645	0.4138	0.4625	0.4092

6-2. 3000K

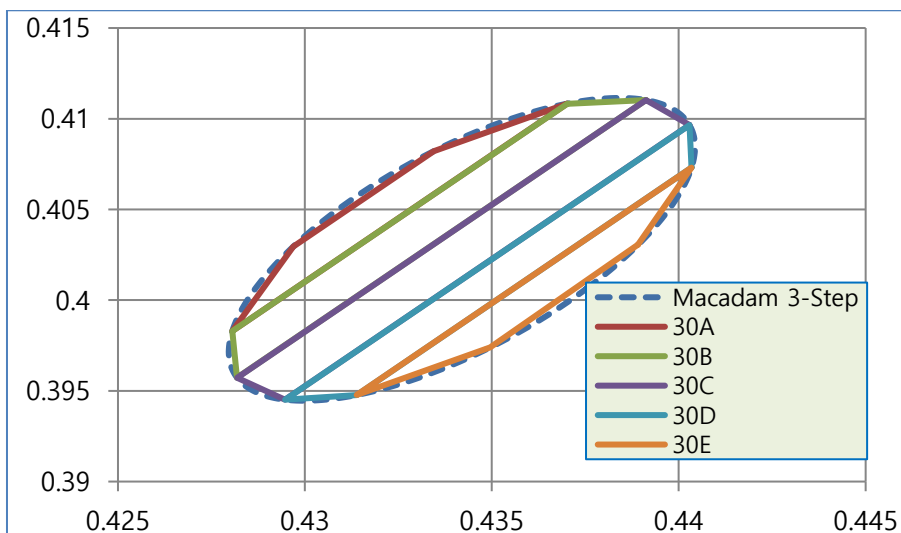

30A		30B		30C		30D		30E	
X	Y	X	Y	X	Y	X	Y	X	Y
0.4370	0.4108	0.4391	0.4110	0.4403	0.4097	0.4403	0.4073	0.4389	0.4031
0.4334	0.4082	0.4370	0.4108	0.4391	0.4110	0.4403	0.4097	0.4403	0.4073
0.4297	0.4030	0.4281	0.3983	0.4282	0.3957	0.4295	0.3945	0.4314	0.3948
0.4281	0.3983	0.4282	0.3957	0.4295	0.3945	0.4314	0.3948	0.4350	0.3974
0.4370	0.4108	0.4391	0.4110	0.4403	0.4097	0.4403	0.4073	0.4389	0.4031

6-3. 3500K

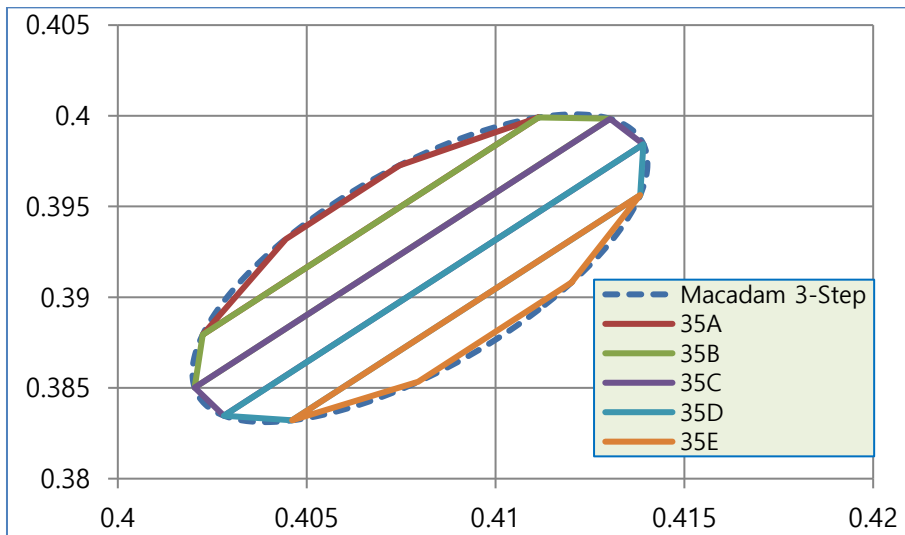

35A		35B		35C		35D		35E	
X	Y	X	Y	X	Y	X	Y	X	Y
0.4111	0.3999	0.4130	0.3998	0.4139	0.3984	0.4138	0.3956	0.4120	0.3908
0.4075	0.3973	0.4111	0.3999	0.4130	0.3998	0.4139	0.3984	0.4138	0.3956
0.4044	0.3932	0.4023	0.3879	0.4020	0.3850	0.4028	0.3835	0.4046	0.3832
0.4023	0.3879	0.4020	0.3850	0.4028	0.3835	0.4046	0.3832	0.4080	0.3853
0.4111	0.3999	0.4130	0.3998	0.4139	0.3984	0.4138	0.3956	0.4120	0.3908

6-4. 4000K

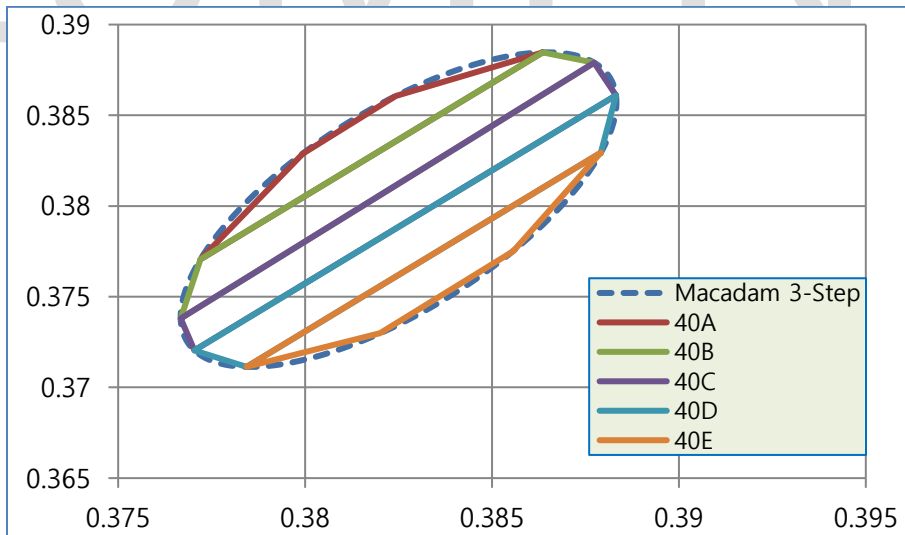

40A		40B		40C		40D		40E	
X	Y	X	Y	X	Y	X	Y	X	Y
0.3864	0.3885	0.3877	0.3879	0.3883	0.3861	0.3879	0.3829	0.3856	0.3775
0.3824	0.3861	0.3864	0.3885	0.3877	0.3879	0.3883	0.3861	0.3879	0.3829
0.3799	0.3829	0.3772	0.3771	0.3767	0.3738	0.3770	0.3720	0.3784	0.3711
0.3772	0.3771	0.3767	0.3738	0.3770	0.3720	0.3784	0.3711	0.3820	0.3730
0.3864	0.3885	0.3877	0.3879	0.3883	0.3861	0.3879	0.3829	0.3856	0.3775

6-5. 5000K

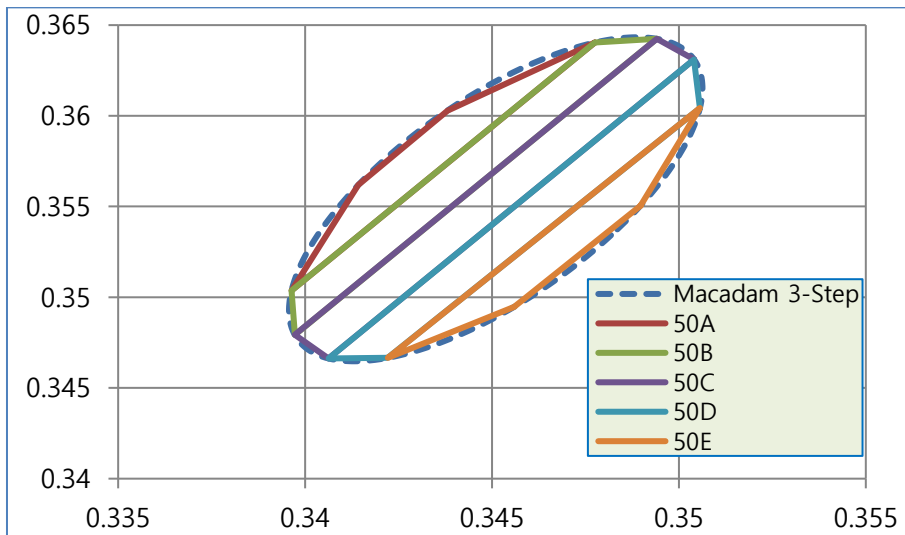

50A		50B		50C		50D		50E	
X	Y	X	Y	X	Y	X	Y	X	Y
0.3478	0.3640	0.3494	0.3642	0.3504	0.3631	0.3506	0.3604	0.3490	0.3550
0.3438	0.3603	0.3478	0.3640	0.3494	0.3642	0.3504	0.3631	0.3506	0.3604
0.3414	0.3562	0.3396	0.3504	0.3397	0.3479	0.3406	0.3466	0.3422	0.3467
0.3396	0.3504	0.3397	0.3479	0.3406	0.3466	0.3422	0.3467	0.3456	0.3495
0.3478	0.3640	0.3494	0.3642	0.3504	0.3631	0.3506	0.3604	0.3490	0.3550

6-6. 5700K

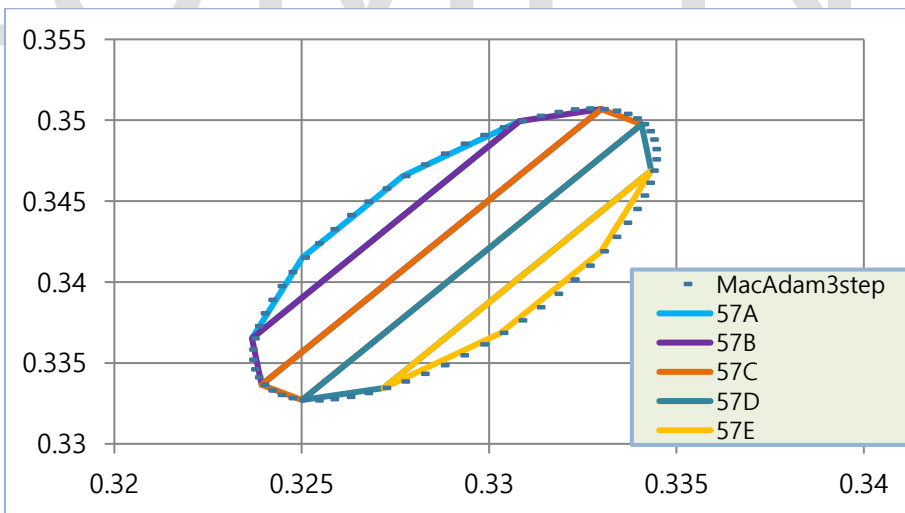

57A		57B		57C		57D		57E	
X	Y	X	Y	X	Y	X	Y	X	Y
0.3308	0.3500	0.3330	0.3507	0.3341	0.3497	0.3343	0.3469	0.3330	0.3419
0.3277	0.3465	0.3308	0.3500	0.3330	0.3507	0.3341	0.3497	0.3343	0.3469
0.3250	0.3415	0.3237	0.3365	0.3239	0.3337	0.3250	0.3327	0.3272	0.3334
0.3237	0.3365	0.3239	0.3337	0.3250	0.3327	0.3272	0.3334	0.3303	0.3369
0.3308	0.3500	0.3330	0.3507	0.3341	0.3497	0.3343	0.3469	0.3330	0.3419

7. Characteristic Graphs

7-1 Voltage Characteristics(Ta=25°C)

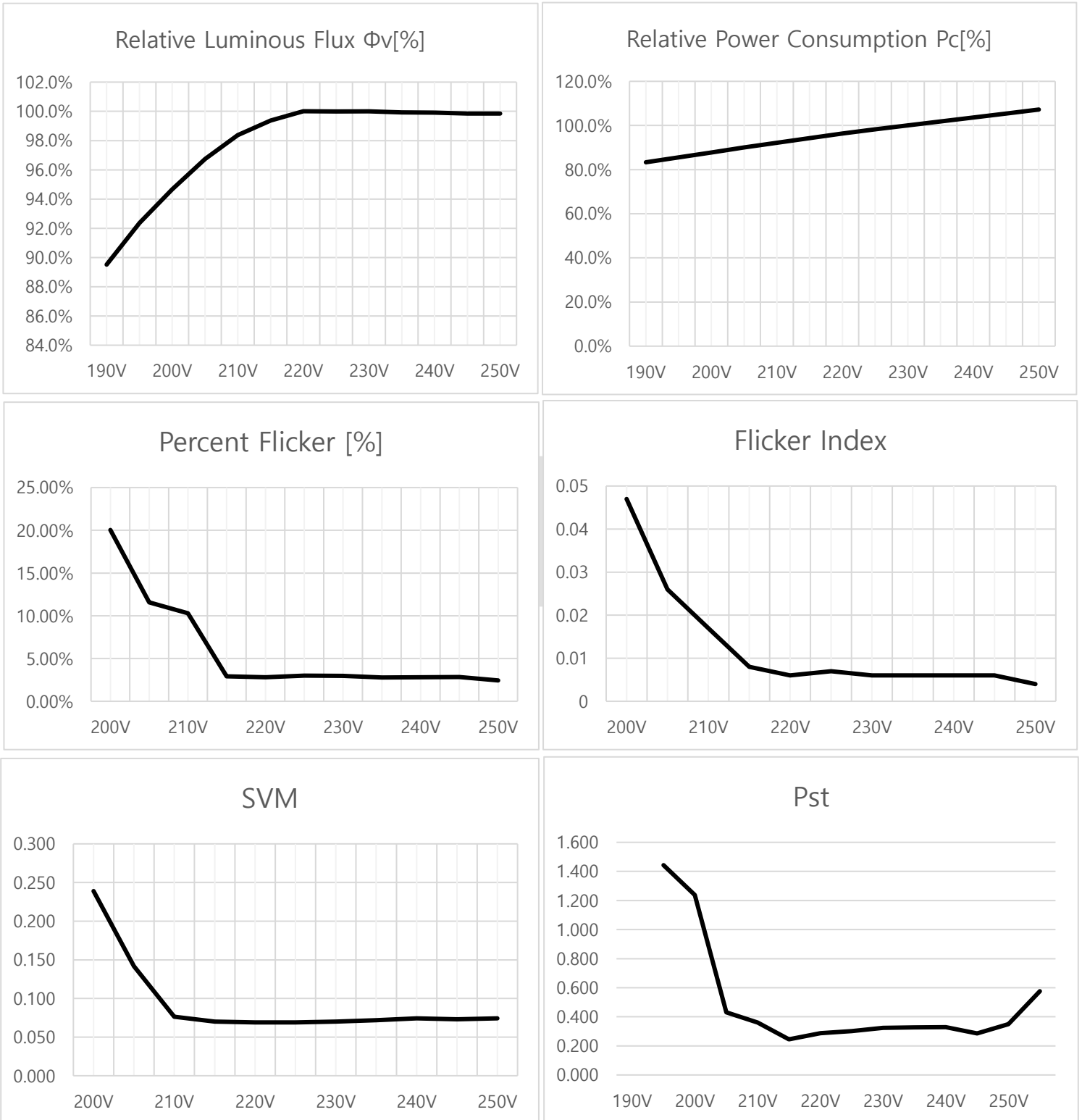

7-2 Spectrum Characteristics(Ta=25°C)

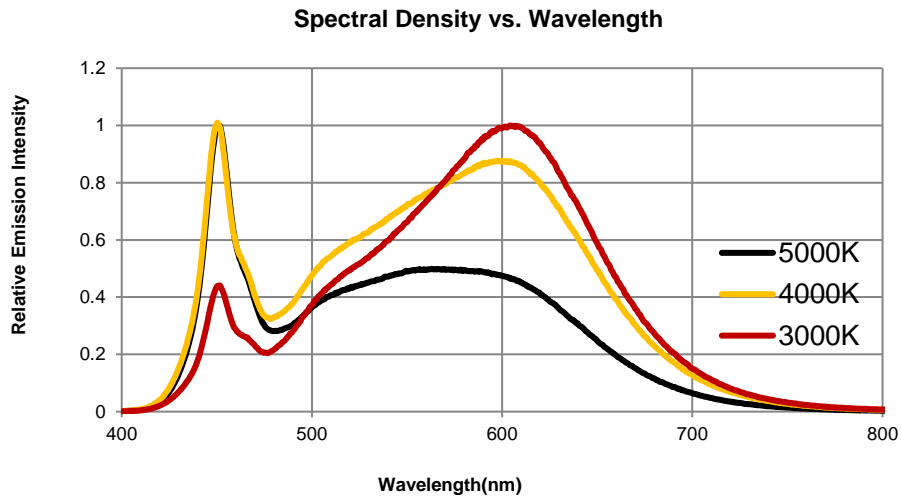

7-3 Temperature Characteristics

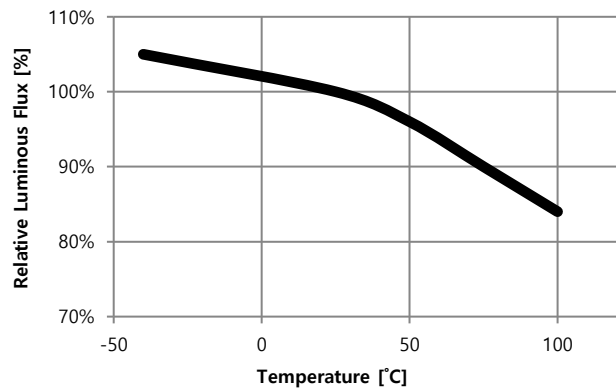
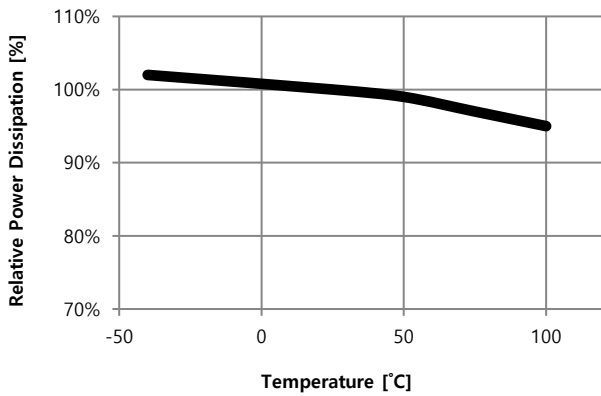

8. Outline Dimensions

8-1 PCB Dimensions

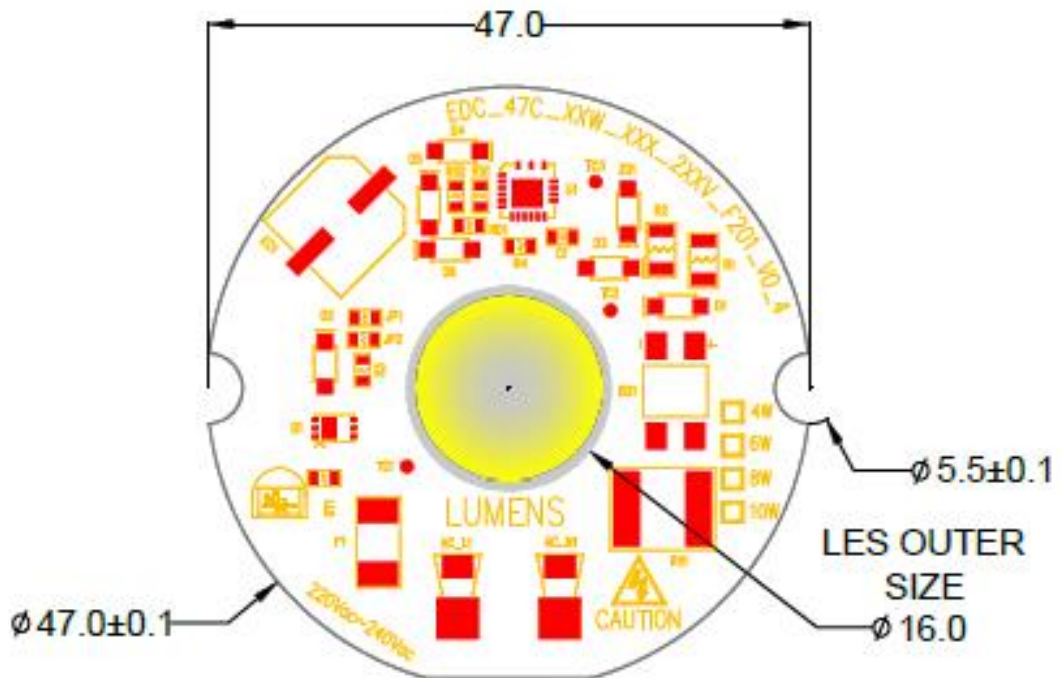

Unit : mm

- 1) Outline Diameter : 47Φ , Height : 7.6mm (Include PCB)
- 2) Tolerance - All measurements are ± 0.2 mm unless otherwise indicated.

9. EDC Module Marking

- A. Information Identification by report on the PCB (Silk)
 - Module Identification Code
- B. LED Module Laser Marking

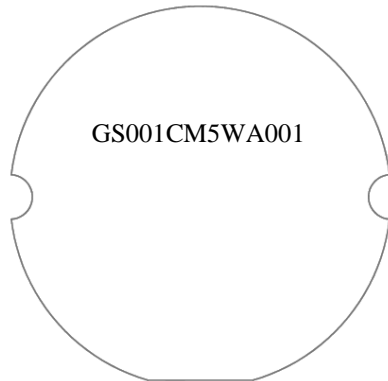

<PCB Bottom>

B-1 Traceability Code Table

No	1	2	3	4	5	6	7	8	9	10	11	12	13
Marking	G	S	0	0	1	C	M	5	W	A	0	0	1
Meaning	SMT Site	Chip Manufacturer	Group No.			SMT Year/Month/Day			PCB Manufacturer	Classification	Serial No.		
Ciphers	1	1	3			3			1	1	4		
How to Use	G : K2	S : Semicon	001			1st Year (A~Z) 2nd : Month(A~M) 3rd : Day(A~Z,1~7)			W : Wavenics	A	001		

B-2 Traceability Code Marking Table

SMT Site

SMT Site	D	L	B	K	Y	W	H	G	T
Code	1 st Vendor	2 nd Vendor	3 rd Vendor	4 th Vendor	5 th Vendor	6 th Vendor	7 th Vendor	8 th Vendor	9 th Vendor

Chip Manufacturer

Chip Manufacturer	F	P	E	T	K	I	V	G	O	S
Code	1 st Vendor	2 nd Vendor	3 rd Vendor	4 th Vendor	5 th Vendor	6 th Vendor	7 th Vendor	8 th Vendor	9 th Vendor	10 th Vendor

SMT Year/Month/Day

Year	2012	2013	2014	2015	2016	2017	2018	2019	2020	2021	2022	2023	2024	2025	2026	2027	2028	2029	2030	2031	2032	2033	2034	2035							
	A	B	C	D	E	F	G	H	J	K	L	M	N	P	Q	R	S	T	U	V	W	X	Y	Z							
month	01월	02월	03월	04월	05월	06월	07월	08월	09월	10월	11월	12월																			
	A	B	C	D	E	F	G	H	J	K	L	M																			
day	01일	02일	03일	04일	05일	06일	07일	08일	09일	10일	11일	12일	13일	14일	15일	16일	17일	18일	19일	20일	21일	22일	23일	24일	25일	26일	27일	28일	29일	30일	31일
	A	B	C	D	E	F	G	H	J	K	L	M	N	P	Q	R	S	T	U	V	W	X	Y	Z	1	2	3	4	5	6	7

PCB Manufacturer

PCB Manufacturer	F	P	E	T	K	I	V	G	O	S
Code	1 st Vendor	2 nd Vendor	3 rd Vendor	4 th Vendor	5 th Vendor	6 th Vendor	7 th Vendor	8 th Vendor	9 th Vendor	10 th Vendor

10. Package And Marking Of Product

A. Tray Information

Size : 200mm x 190mm x 16.5mm

Color : Clear

Surface Resistivity : $10^6 \sim 10^9 \Omega/\text{Sq.}$

B. Package

9 pcs are packed in one tray.

Packing TRAY : Stack Up 21 Layers

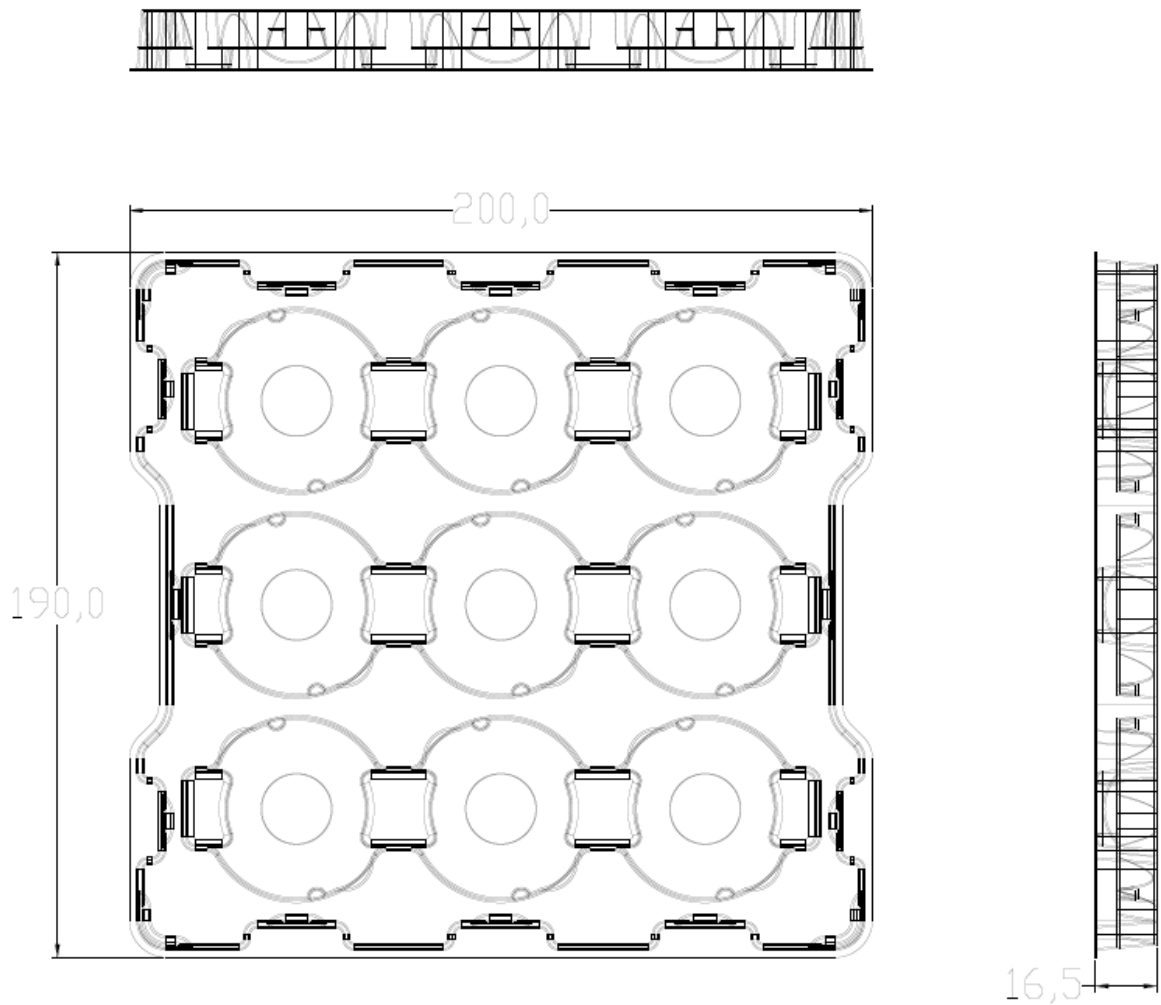

- Side view -

C. Box Packing Specifications

Tray products (numbers of products are 9 pcs) packed.

There is no product on the top tray

21 Tray (total maximum number of products are 180pcs) packed in a box.

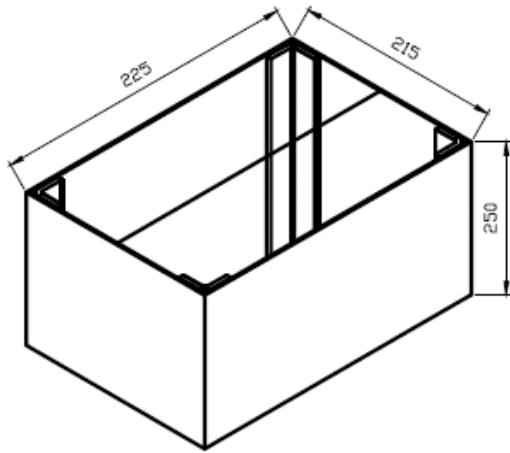

225 X 215 X 250 mm

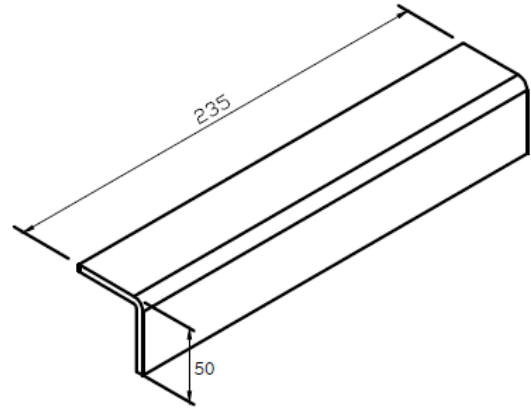

50 X 50 X 235 mm

LUMENS

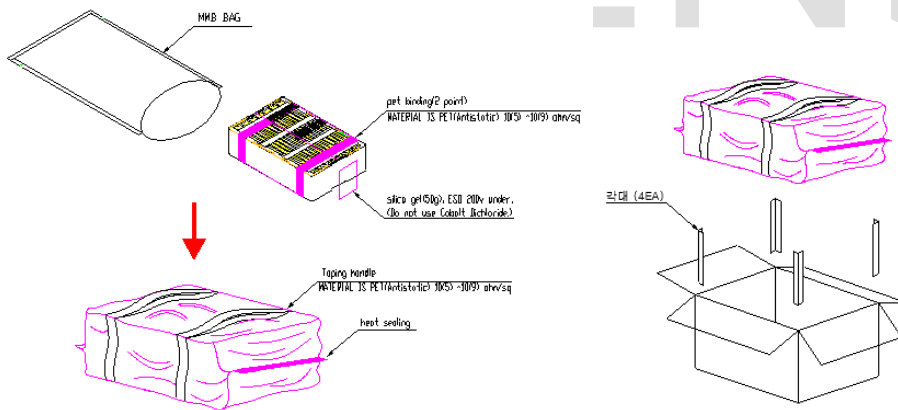

D. Pallet Loading

Box is stacked by 4 layers on the Pallet.

Each layer has 20 boxes

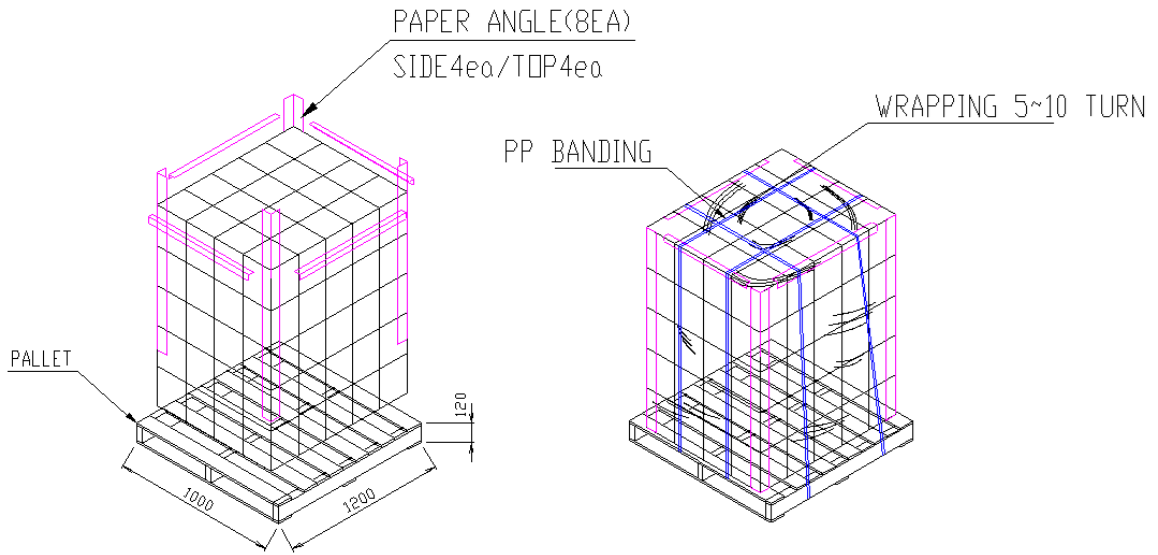

Size : 1,000mm(W) X 1,200mm(L) X 1,560mm(H)

LUMENS

E. BOX Label

Specifying Customer, Model, Customer Part No, Lot No, Quantity
 On both trays and boxes, the same label is attached.

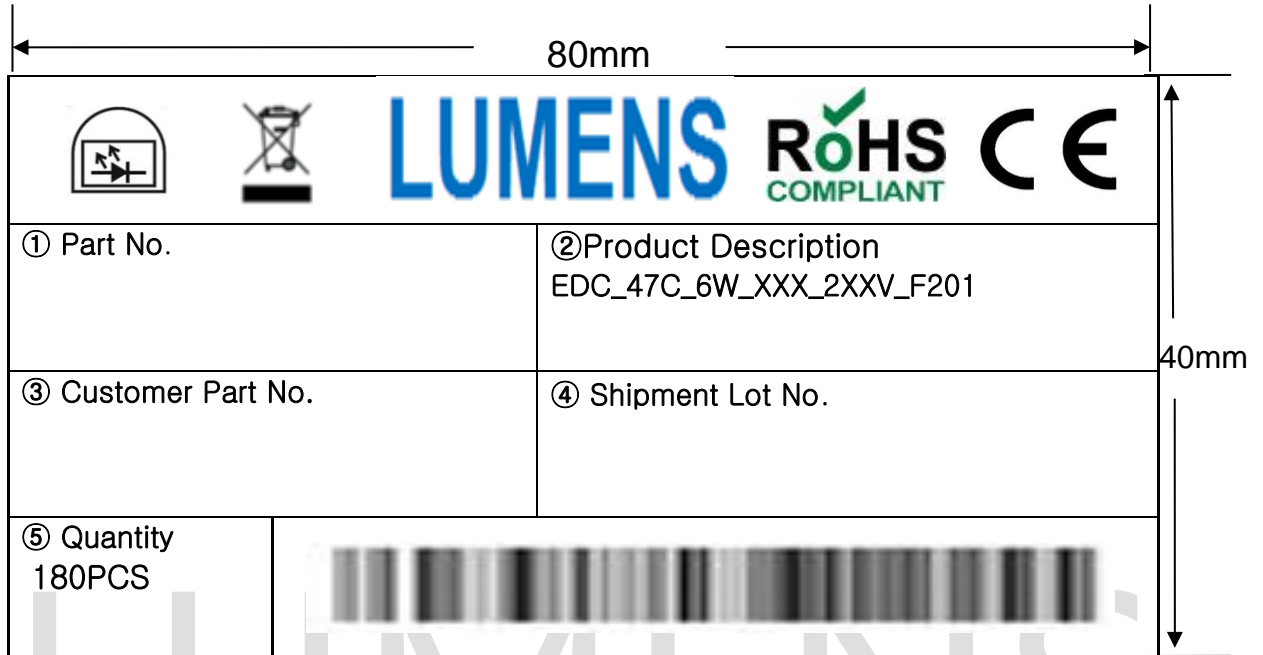

<Example>

- X : CRI (80CRI=8, 90CRI=9) ,
- XX : CCT (2700K=27, 3000K=30 , 3500K=35, 4000K=40, 5000K=50, 5700K=57)
- 2XXV : Input Voltage (220Vac=220V, 230Vac=230V)

1. PART No
2. Model Name.
3. Customer Part NO
4. Shipment Lot No.
5. Quantity.

F. Shipment Lot No. Indication

No	1	2	3	4	5	6	7	8	9	10	11	12	13	14	15	
Marking	C	G	X	-	1	0	0	2	0	2	-	A	0	0	1	
Meaning	COB	SMT Site	Default	Default	Packing Year/Month/Day						Default	Default	Packing serial No.			
Ciphers	1	1			6								3			
How to Use	C : COB	G : K2			1st~2nd : Last two digits of Year 3rd~4th : Month(01~12) 5th~6th : Day(01~31)								001			

11. Cautions

- ◆ The LED Module itself and all its components may not be mechanically stressed.
- ◆ Make sure proper discharge prior to starting work.
- ◆ DO NOT touch any of the circuit board, components or terminals with body or metal while circuit is active.
- ◆ Installation of LED Module needs to be made with regard to all applicable electrical and safety standards. Only qualified personnel should be allowed to perform installation.
- ◆ DO NOT add or change wires while circuit is active.
- ◆ DO NOT make any modification on module.
- ◆ DO NOT use adhesives to attach the LED that outgas organic vapor.
- ◆ DO NOT use together with the materials containing Sulfur.
- ◆ The LED Module needs to be mounted on a heat sink providing adequate thermal dissipation.
- ◆ DO NOT exceed the values given in this specification
- ◆ Be cautious when soldering to board so as not to create a short between different trace patterns.
- ◆ Keep cautions not to apply higher voltage above the maximum rating. Otherwise damage may occur.
- ◆ Pay attention not to exceed the maximum operation temperature of 85°C at the Tc1 Point when the modules are used in an enclosed environment.
(Tc1 Temperature Condition ≤ 85°C)
(Tc1 + 30°C ≐ Maximum LES temperature(Tj)) : Depends on specification of heat sink
- ◆ DO NOT assemble in conditions of high moisture and/or oxidizing gas such as Cl, H2S, NH3, SO2, NOx, etc.
- ◆ The module should also not be installed in end equipment without ESD (Electrical Static Discharge) protection.
- ◆ Damage by corrosion will not be allowed as defect claim. Lumens LED Module is recommended for Indoor use only.
- ◆ Great care should be taken not to see directly the operated lighting LED. If not the intense light should cause the damage to eye. Use proper goggles to protect your eyes during operation.
- ◆ Long time exposure to sunlight or UV can cause the lens to discolor.
- ◆ Moisture-Proof package
 1. When moisture is absorbed into the LED light engine it may vaporize and expand products during manufacturing. There is a possibility that this may cause exfoliation of the contacts and damage to the optical characteristics of the LEDs. For this reason, the moisture-proof pack is used to keep moisture to a minimum in the package.
 2. A pack of a moisture-absorbent material (silica gel) is inserted into the shielding bag. The silica gel changes its color from blue to pink as it absorbs moisture.
- ◆ Storage Conditions
 1. Before opening the package: The LED light engines should be kept at 30°C or less and 90% RH or less. The LED light engines should be used within a year. When storing the LED light engines, moisture-proof packaging with moisture-absorbent material (silica gel) is recommended.
 2. After opening the package: The LED light engines should be kept at 30°C or less and 70% RH or less. The LEDs should be soldered within 168 hours (7 days) after opening the package. If unused LED light engines remain, they should be stored in moisture-proof packages, such as sealed containers with packages of moisture-absorbent material (silica gel). It is also recommended to return the LED light engines to the original moisture-proof bag and to reseal the moisture-proof bag again.
 3. Please avoid rapid transitions in ambient temperature, especially in high humidity environments where condensation can occur.
- ◆ Basic insulation is based on 230Vac.



NOTE :

All the information published by Lumens is considered to be accurate and reliable. However Lumens does not warrant that product descriptions or other contents in this data sheet is accurate, complete, reliable, current, or error-free. Lumens disclaims any and all warranties and liabilities of an kind, including without limitation, warranties of non-infringement or implied warranty of merchantability of fitness for a particular purpose. The appearance and specifications of the product can be changed to improve quality, performance and/or design without advance notice. Lumens products are not authorized for use as critical components in life support devices or systems without the express written approval from the managing director of Lumens.